

step
ficha técnica
datasheet

ref. 5550449

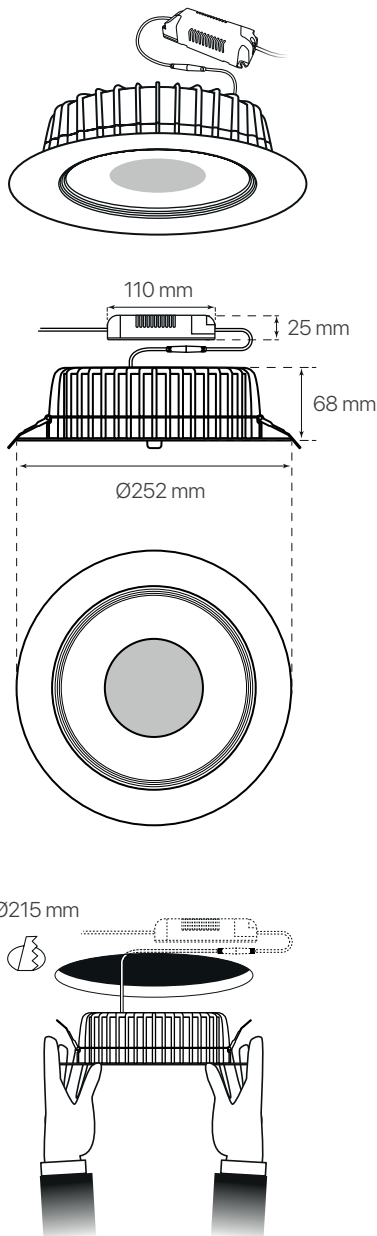
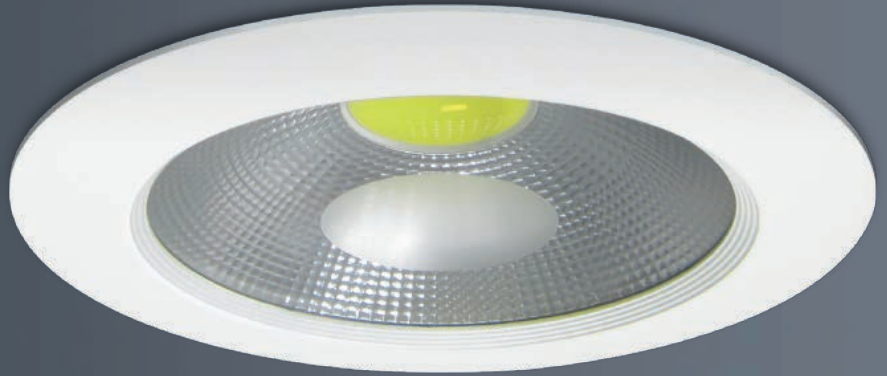

Nombre / Name	step • downlight led empotrable
Referencia / Reference	5550449
Materiales / Materials	Aluminio + cristal / Aluminum + glass
Difusor / Diffuser	Cristal / Crystal
Potencia / Power	30W
Temperatura de color / Color temperature	6500K
Flujo luminoso / Luminous flux	2900lm
Dimable / Dimmable	No
Ángulo de apertura / Beam angle	110°
Ángulo de inclinación / Inclination angle	-
IP	20
IK	08
F.P.	0.9
UGR	20
IRC	80
Chip	EPISTAR COB
Driver	i-TEC series
Vida media (duración) / Average life	+30.000h
Clase energética / Energy class	A++
Aislamiento eléctrico / Electrical isolation	Clase I / Class I
Colores / Colors	Blanco / White
Medida exterior / Product size	Ø252mm x 68mm
Medidas de corte / Cutting measurements	Ø215mm
Tª (ambiente/trabajo) / Tª (environment/work)	-20°C ~ 50°C
Input	AC85 ~ 265V
Output	DC30 ~ 38V 900mA ±5%
Frecuencia / Frequency	50 / 60Hz
Peso / Weight	1,27kg
Certificados / Certificates	CE RoHS
Garantía / Warranty	2 años / 2 years